



# BERYL

INDOOR & OUTDOOR RENTAL LED DISPLAY





## OVERVIEW

The BERYL is made for rental purposes but can also fit permanent applications. It's a very user-friendly cabinet with a fine pixel pitch ranging from P1.5 to P4.8. The integration, disassembly, and maintenance process can easily be done by one technician as the BERYL is designed so that every feature facilitates its manipulation. It's an ideal touring solution for professionals.



**APPLICATION**  
Indoor / Outdoor



**INGRESS PROTECTION**  
IP20 (indoor)  
IP66 (outdoor)



**PIXEL PITCH**  
P1.5 P1.9 P2.6 (indoor)  
P2.9 P3.9 P4.8 (outdoor)



**DISPLAY AREA (W x H)**  
500 x 500 mm  
500 x 1000 mm  
125 x 500 mm (angle cabinet)  
125 x 1000 mm (angle cabinet)



**BRIGHTNESS**  
≤ 1000 NITS (indoor)  
≤ 5500 NITS (outdoor)



**WEIGHT**  
8.5 - 13 kg/cabinet  
2.5 - 5 kg/ angle cabinet



**MATERIAL**  
Die-casting aluminum



**MAINTENANCE**  
Front & back maintenance



## FEATURES



## OUTSTANDING DISPLAY QUALITY

With its fine pixel pitch and Black Face SMD LEDs, the BERYL is one of the highest resolution LED displays for touring use. High contrast and high

brightness will ensure a sharp image resolution visible from afar, making the BERYL the best choice for scenographic applications.



**CUSTOMIZABLE TOOLLESS CURVE LOCKING SYSTEM**



**SUPPORTS MULTIPLE INTEGRATION METHODS**

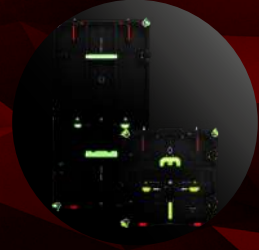

**PHOSPHORESCENT HANDLES / CLIMBING HOLDS**



## WIDE COLOR RANGE

The wide-gamut RGB color space used by the BERYL was developed by Adobe Systems and offers a large range of vivid colors. Combined with the display quality of the BERYL, this allows you to offer your audience a large range of complex or simple color layouts with sharp contrast and resolution.

## TOURING ORIENTED FEATURES

Many aspects of the BERYL were carefully thought to facilitate its touring orientation, such as a lightweight heavy duty frame, toolless safety screws, phosphorescent climbable handles, and many accessories (hanging bars, floor stacking supports, etc.).

## CUSTOMIZABLE INTEGRATION

The BERYL supports several types of integration, as it can be hung from a ceiling, stacked on the floor or even affixed to a structure. Artixium can provide any accessory needed for these different types of installation. The two cabinet sizes are compatible with each other and provide a toolless curve locking system to fit tailored installations on the spot. The BERYL can be integrated at 90° concave angles and is both glare-resistant and scratch-resistant. These features make the BERYL easy to integrate and easy to disassemble, the same application can follow you all along your touring process, saving you both time and money.

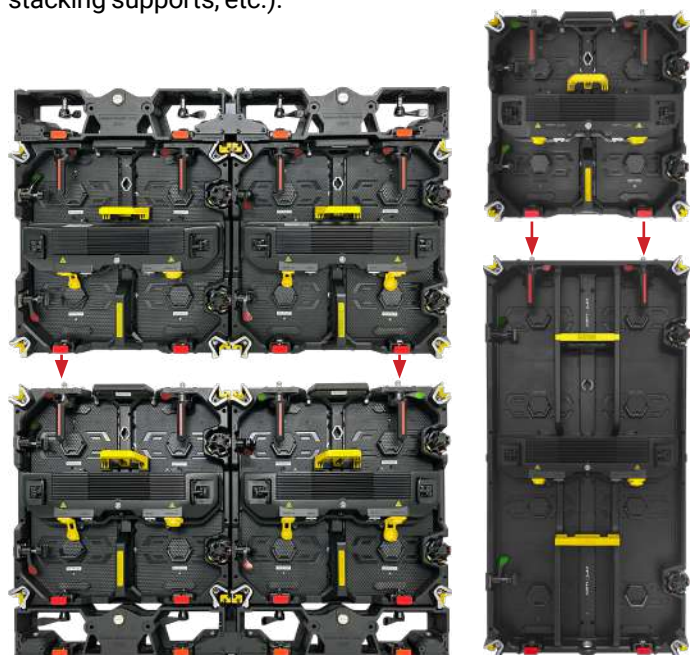

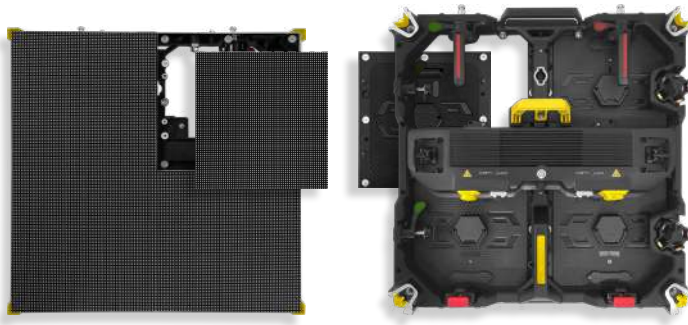

## UNIVERSAL MODULES

Each of the BERYL's modules can fit in any part of the cabinet, meaning that your spare parts will always fit your maintenance needs. This feature is very useful when it comes to touring LED screens, which often need to be maintained on the spot in the shortest delays.



## 90° ANGLE LED CABINET

The BERYL P3.9 is one of the few products on the LED display market to offer angle LED cabinets, for seamless 90° applications. Many LED cabinets offer a beveled version, that lets you integrate your giant LED screen at a 90° angle and yet still lets a little space at the junction of the two cabinets. With the BERYL angle cabinets, your LED display does not have that problem, as it allows a regular curve for your angle application to be fully and seamlessly continuous.

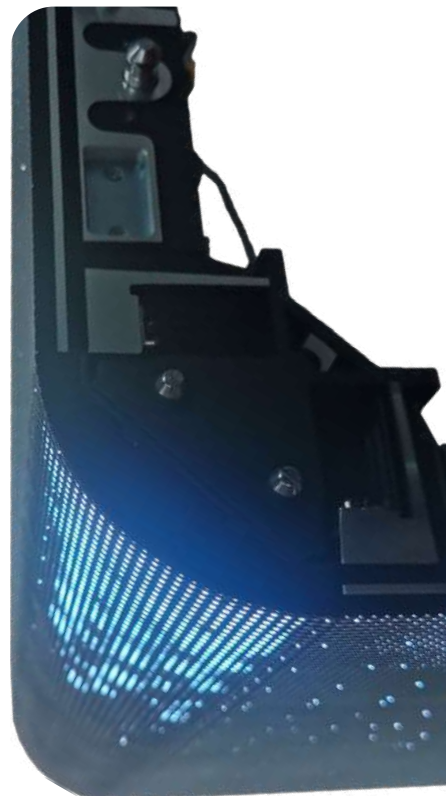



## MINILED 4IN1

The BERYL P1.5 & P1.9 use MiniLED 4in1 technology. It consists in 4 small LEDs encapsulated in the space that a normal SMD LED represents. This technology offers numerous advantages, but the most noteworthy are the tremendous gains in both image resolution and LED durability. The first one is quite self-explanatory, as you multiply the effective number of LEDs by 4 on

your modules. The second one is due to the encapsulation, which works like the GME technology, but on the LED level rather than on the whole module. While adding to the LEDs resistance, it still allows a qualified technician to repair each MiniLED 4in1 individually, while this operation is almost impossible on a GME module.

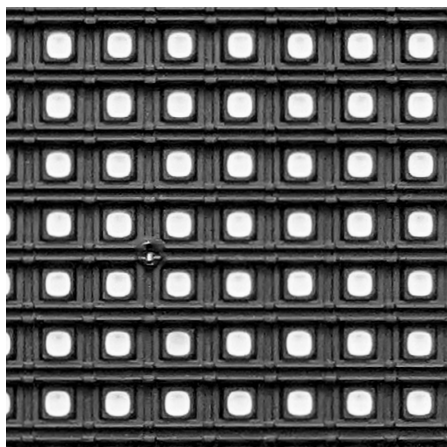

SMD LED

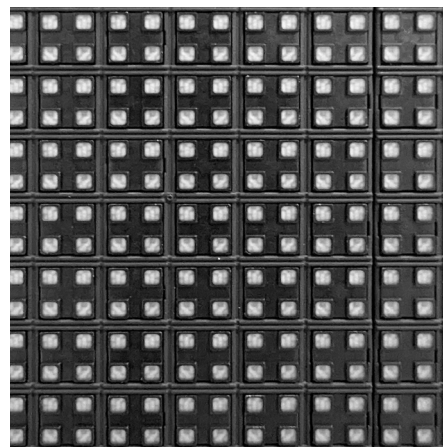

MINILED 4IN1

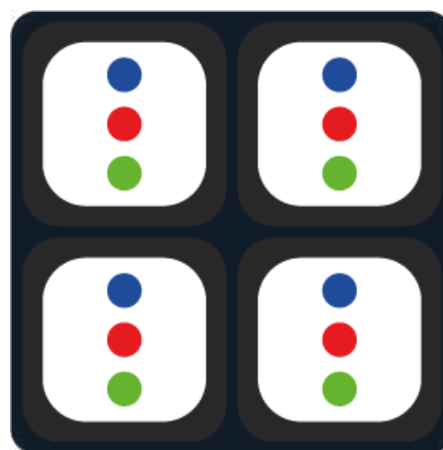



# TECHNICAL SPECIFICATIONS



Product Parameters	Unit	INDOOR				OUTDOOR	
		1.5	1.9	2.6	2.9	3.9	4.8
Pixel Pitch	mm	1,56	1,95	2,60	2,98	3,91	4,81
LED		MiniLED 4in1		SMD1515 Black face (full black face option available)		SMD1921 Black face (full black face option available)	
Application		Touring System					
Ingress Protection	IP	IP20				IP66	
Brightness	cd/sqm	≤ 800 Nits @5volts		≤ 1000 Nits @5volts	≤ 5000 NITS @5volts	≤ 5500 NITS @5volts	
Color Temperature after calib (adjustable)	deg. K	6500					
Viewing Angle (50% brightness)	deg.	140(+/-70) H / 140 V					
Cabinet Size (WxHxD)	mm	500 x 500 x 93 / 250 x 500 x 98 (angle cabinet)				500 x 500 x 93 / 500 x 1000 x 90 / 250 x 500 x 98 (angle cabinet)	
Display area (WxH)	mm	500 x 500 / 250 x 500				500 x 500 / 500 x 1000 / 250 x 500	
Module Size (WxHxD)	mm	250 x 250 x 15 / 250 x 125 x 15				250 x 250 x 15 / 250 x 500 x 15 / 250 x 125 x 15	
Pixel Matrix Per Cabinet (WxH)	px	320 x 320 / 160 x 320	256 x 256 / 128 x 256	192 x 192 / 96 x 192	168 x 168 / 84 x 168	128 x 128 / 128 x 256 / 64 x 128	104 x 104 / 104 x 208 / 52 x 104
Pixel Matrix Per Module (WxH)	px	160 x 160 / 160 x 80	128 x 128 / 128 x 64	96 x 96 / 96 x 48	84 x 84 / 84 x 42	64 x 64 / 64 x 128 / 64 x 32	52 x 52 / 52 x 104 / 52 x 26
Pixel Density	px/sqm	409600	262144	147456	112896	65536	43264
Weight of cabinet and modules	kg	8.5				8.5 / 13	
Cabinet Material		Die-casting aluminum					
Maintenance Mode		Front & back (remove cap screws for front maintenance)					
Mask specification		95% Plastic + 5% Fiber / Clip type (no screws) / No shaders			95% Plastic + 5% Fiber / Clip type (no screws) / Shaders		
Contrast Ratio		High					
Grey scale (linear)	bit	16					
Brightness control	bit	16					
Processing depth	bit	16					
Color		281 Trillions					
Display Refresh Rate	Hz	3840					
Operation Power	V	AC85-230V					
Max. Power Consumption	W/sqm	560		440	540		640
Average Power Consumption	W/sqm	220		170	200		256
Control Mode		Synchronization					
Video Frame Rate	Hz	50/60Hz					
Input Types Supported		DVI / SDI / HDMI					
3D ready (optional)		Yes					
Calibration		Yes					
Lifetime (50% brightness)	h	50000					
Operating Humidity Range		10-95%					
Operating Temperature Range		-10°C / +50°C					
Screen Uniformity Correction		Below 0.0001 (Out of Control point)					
Certification		CE / ETL / CCC					
Features		Corner Protection / Curve (-3°/-1.5°/1.5°/3°) / Angle cabinet / Hanging bars / Support beams					
Compatibility		1000 x 500 & 500 x 500 cabinets are compatible vertically					



Information and design in this leaflet are subject to Artixium France SAS copyright. No material from this leaflet can be used in any context without ARTIXIUM approval. Designs and specifications are subject to change without notice. All images of ARTIXIUM products components and accessories used here are also subject to change without notice. All information presented herein is based on the latest information at the time of publishing. Actual results of performance and other specifications may differ or vary with production models and may depend on selected options and model ranks.



# TECHNICAL DRAWINGS 1/3

500 X 500 X 93 MM

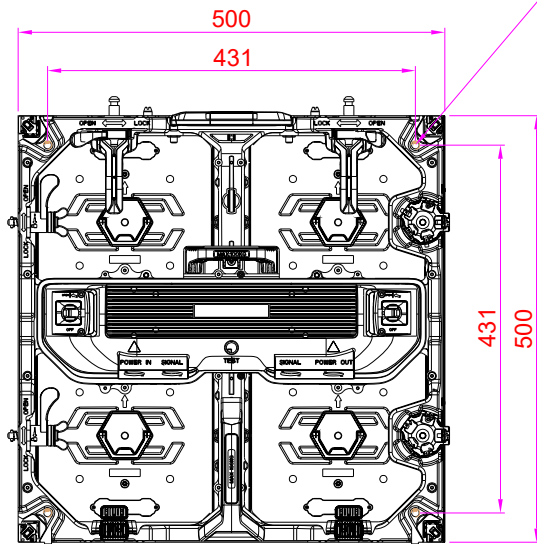
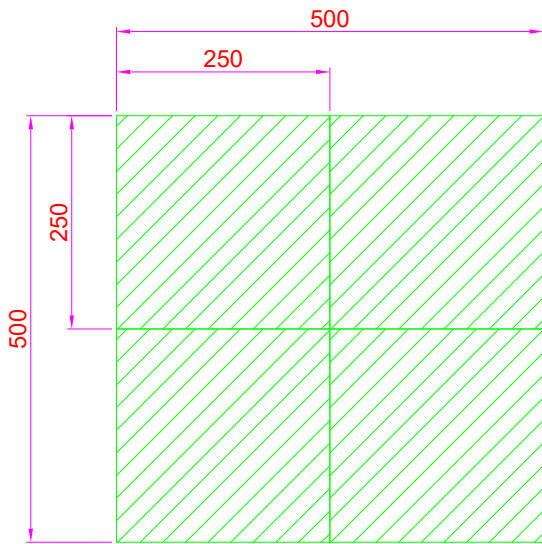

4-M10  
INSTALLATION HOLE

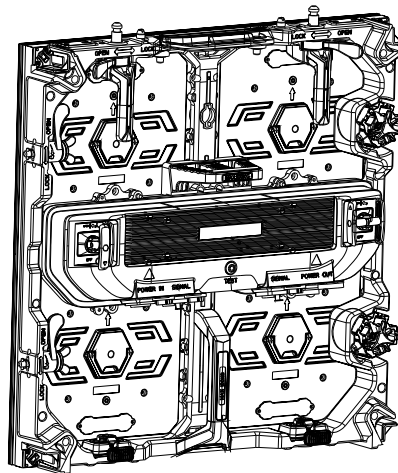
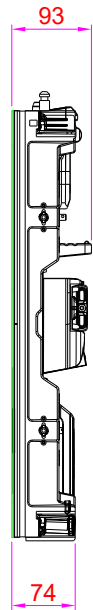



# TECHNICAL DRAWINGS 2/3

500 X 1000 X 90 MM

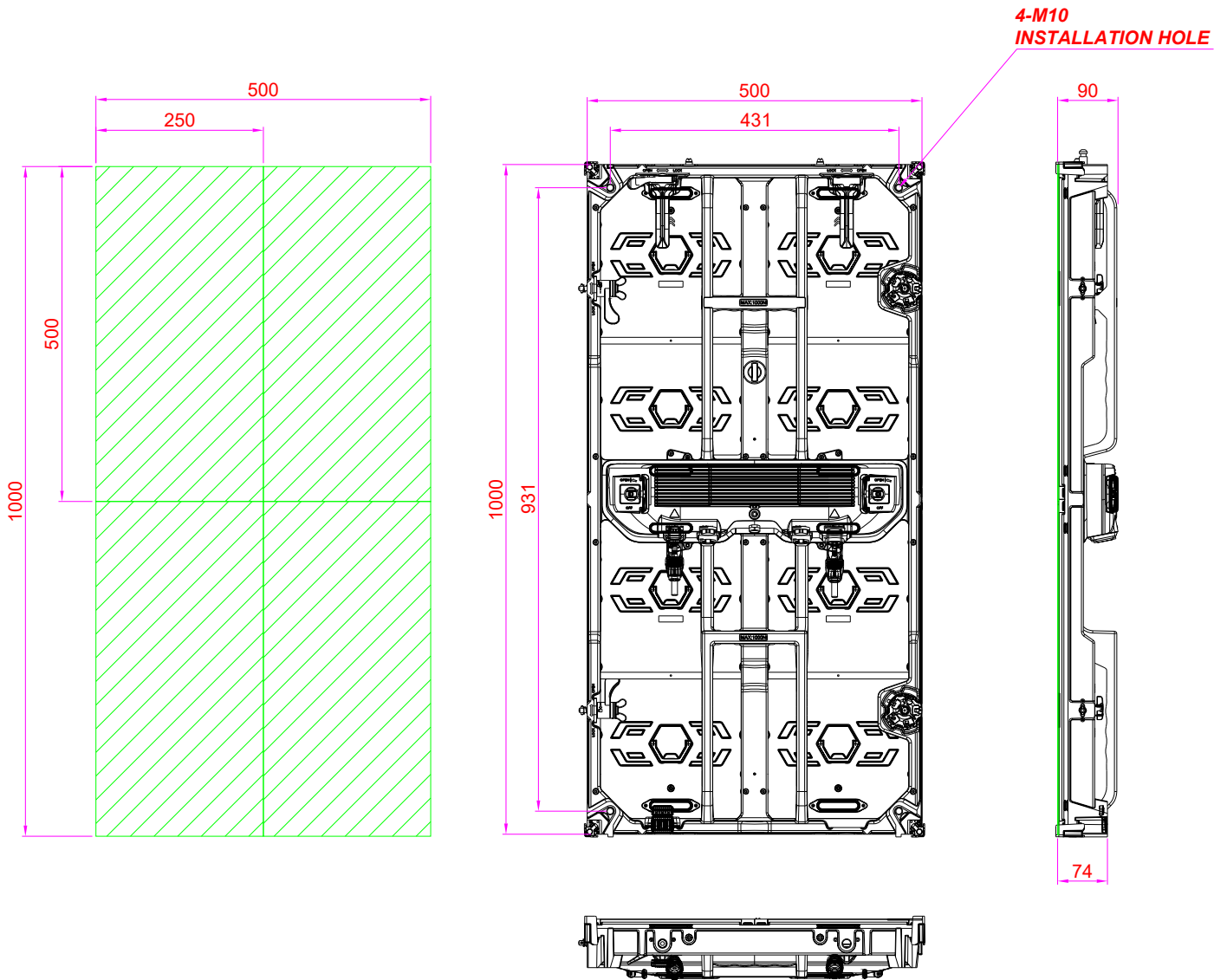





# TECHNICAL DRAWINGS 3/3

250 X 500 X 98 MM - ANGLE CABINET

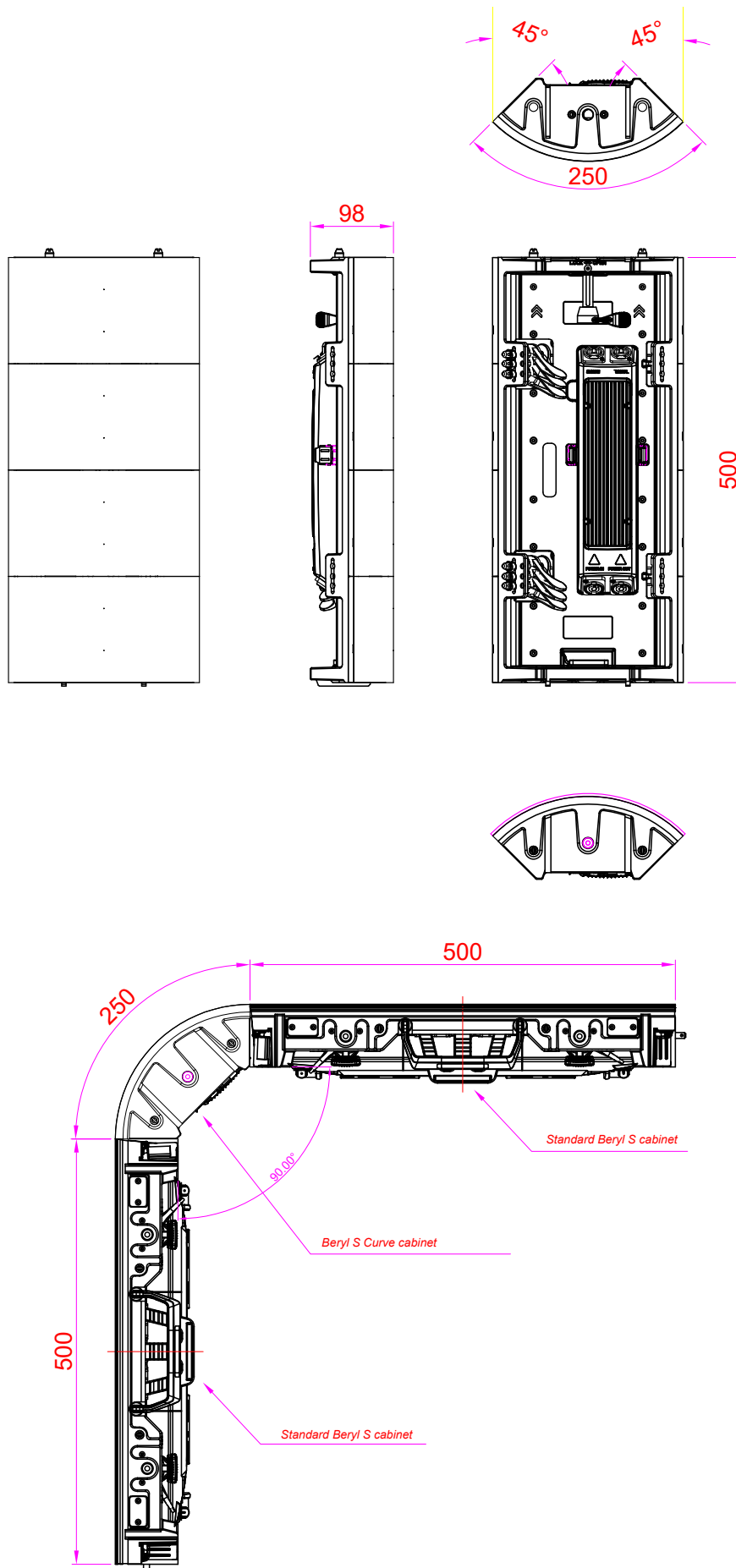



# CONTACT

The Artixium regional branches are the key for the growth and development of our global network all over the world. Artixium's team is a spectrum of different nationalities and cultures, reflecting their global presence and mindset, mak-

ing their communication smooth and hassle-free with clients from all around the world. Customer care, Innovation and flexibility has always been our values and we intend to keep this reputation for many years to come.

## ARTIXIUM FRANCHISES

*"From your project's conception to its completion."*



112 Avenue Franklin Roosevelt  
69120 Vaulx-en-Velin  
France

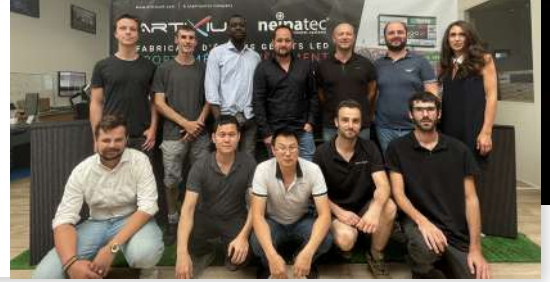

Artixium Operational Center  
518000 Shenzhen  
China



Weissensteinstrasse 90b,  
46149 Oberhausen  
Germany



Merkez Mah. Baglar Cad. A  
Blok Apt. No: 14D/13 Kagithane, Istanbul  
Turkey



 [www.artixium.com](http://www.artixium.com)

 0 428 001 801

 [linkedin.com/company/artixium](https://www.linkedin.com/company/artixium)

 [twitter.com/artixium](https://twitter.com/artixium)

 [contact@artixium.com](mailto:contact@artixium.com)

 [youtube.com/@artixium](https://www.youtube.com/@artixium)

 [facebook.com/artixiumdisplayltd](https://www.facebook.com/artixiumdisplayltd)

 [instagram.com/artixium](https://www.instagram.com/artixium)



Since its creation in 2012 by two european entrepreneurs, Artixium has been evolving and always looking for innovative ways to contribute to the digital transition of our world. It only took a few years for Artixium to become a key player in the LED display industry.

---

[www.artixium.com](http://www.artixium.com)